

### MODULAR COUNTER BALANCE VALVES

### MH※-02、03、04、06 SERIES

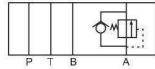

MHA

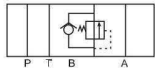

MHB

#### Dimensions

MHA-02

MHB-02

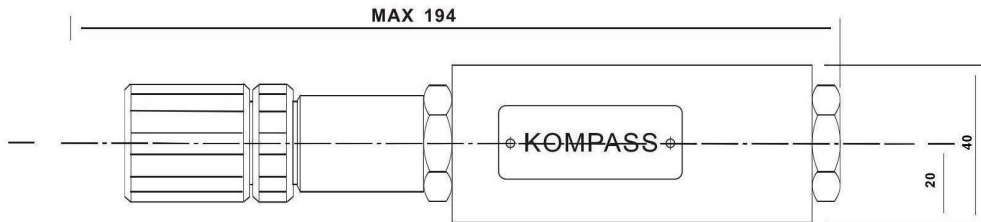
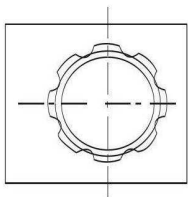
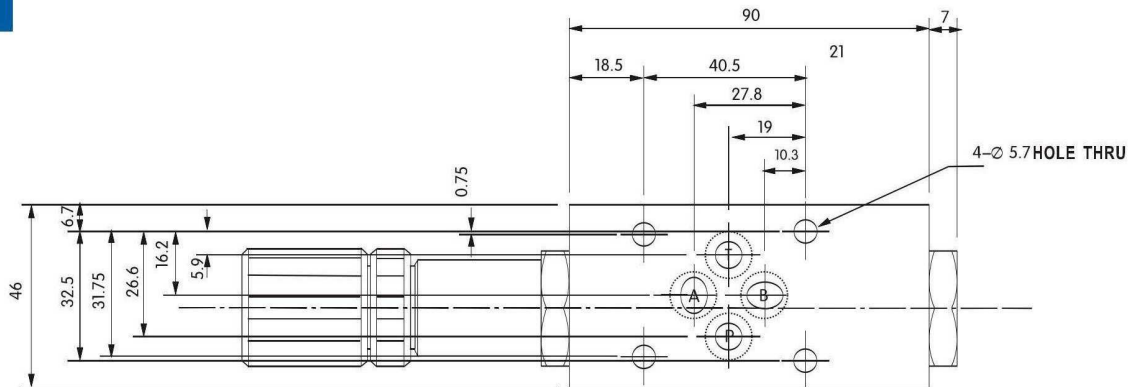

- 規格修改，本公司不另行通知
- Specification is subjected to change without notice.

## Dimensions

### MHA-03 MHB-03

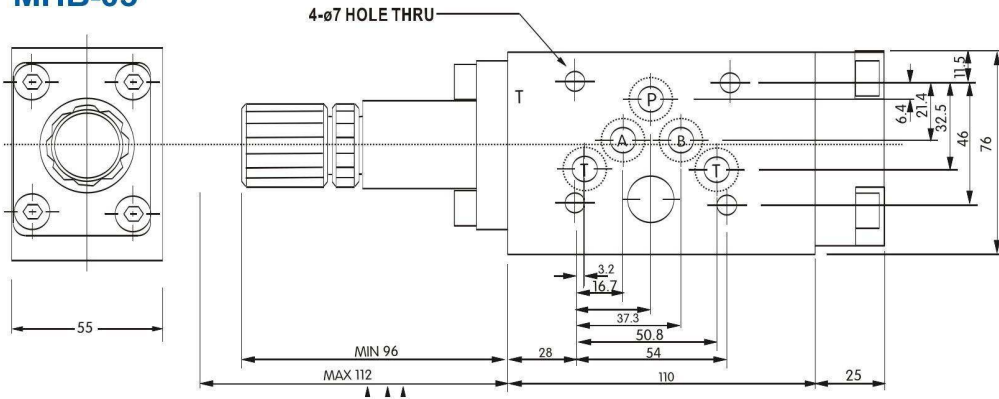

### MHB-04

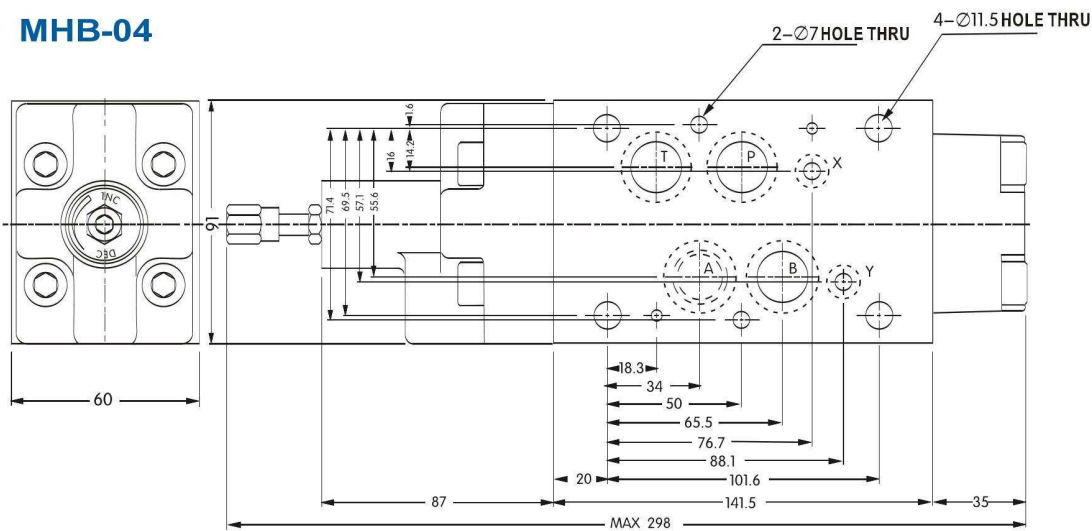

### MHB-06

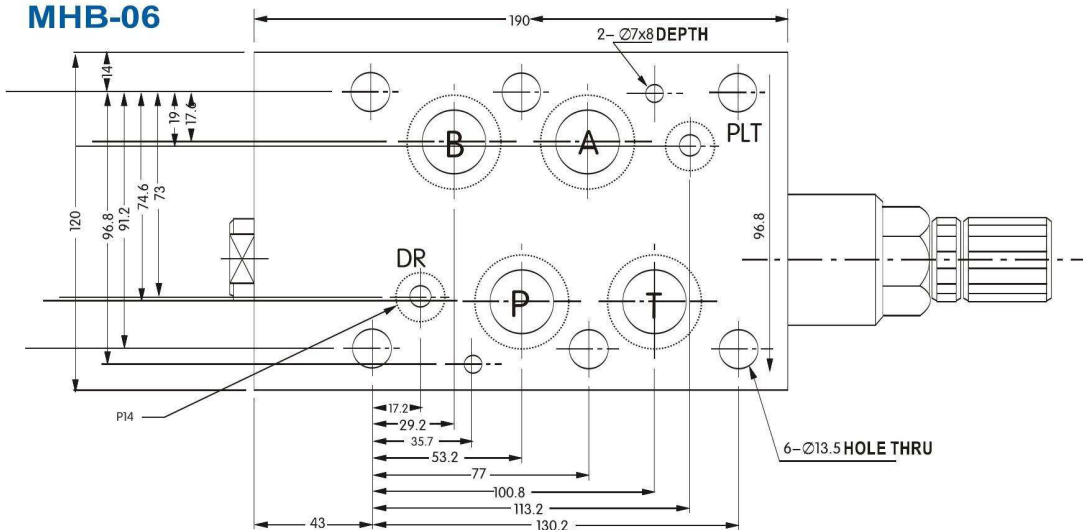

- 規格修改，本公司不另行通知
- Specification is subjected to change without notice.