

# Variable Displacement Vane Pump With Cooling Circulation Pump

變量葉片泵附循環泵系列

VCM-SF/CG  
SM

## 外型尺寸 / MEASUREMENT

VCM - SF - 12 - ※ - ※CG - 20

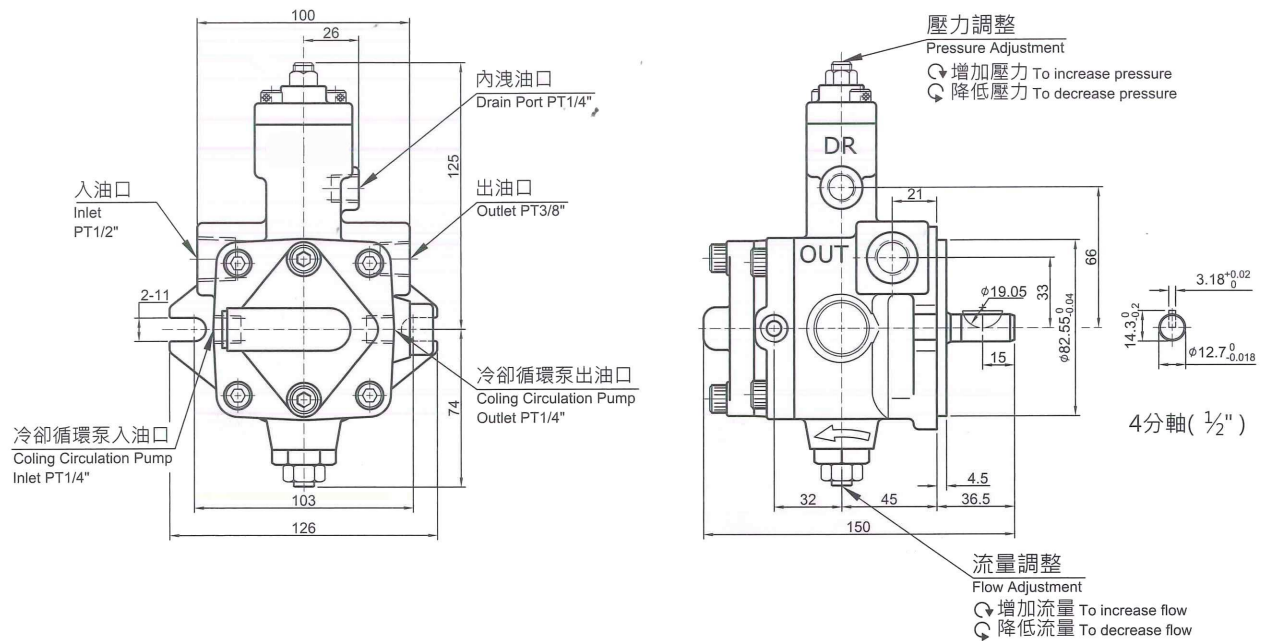

VCM - SF - 30 - ※ - ※CG - 30

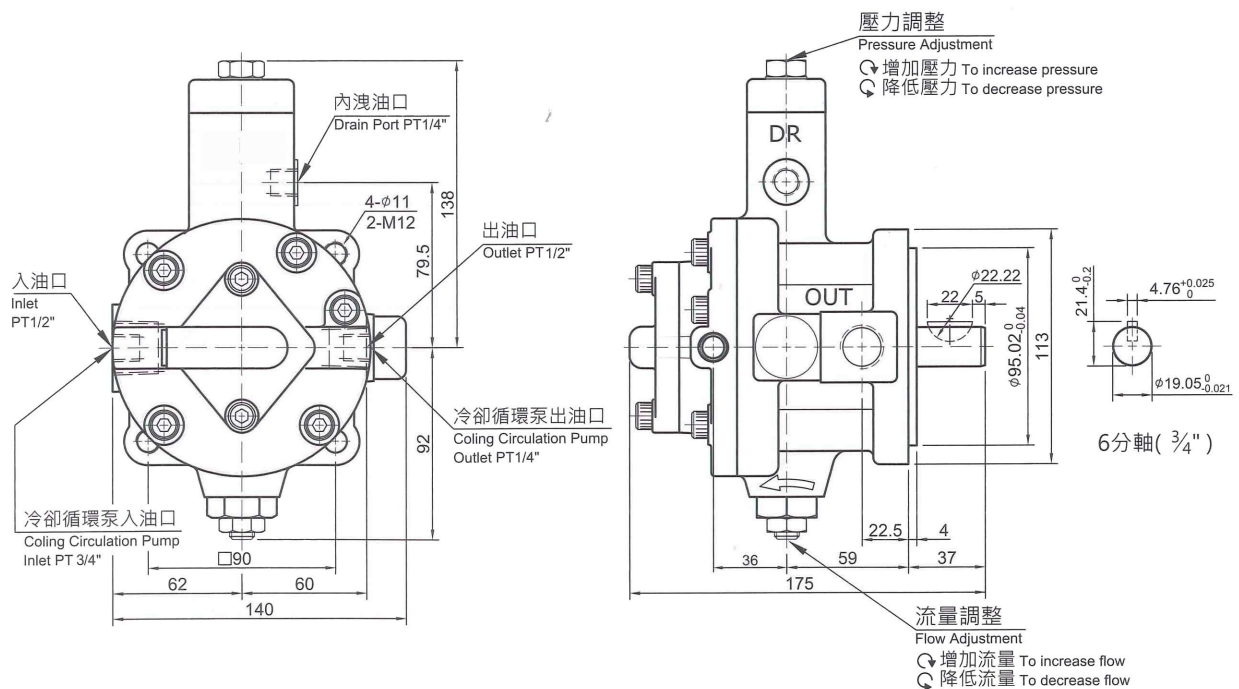

●規格修改，本公司不另行通知  
●Specification is subjected to change without notice.

## 外型尺寸 / MEASUREMENT

### VCM - SM - 30 ※ - 4CG - 20

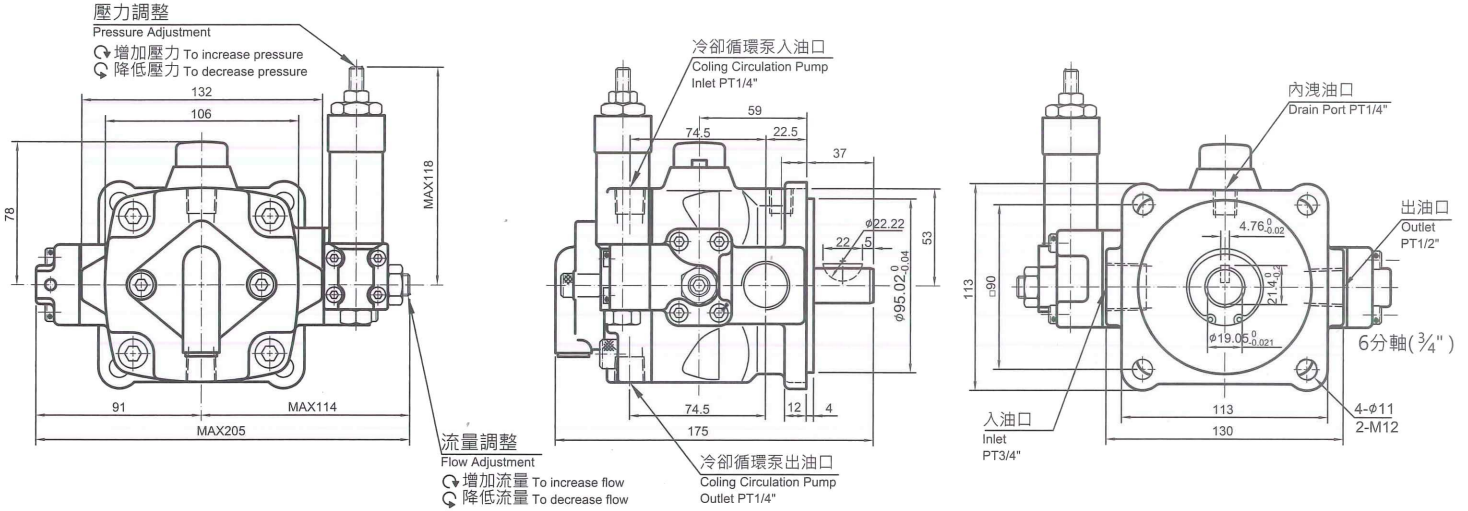

## 性能曲線圖 / PERFORMANCE CURVES

### VCM - SF - 20 ※ - 4CG - 20

測試條件 Testing condition  
 操作用油 Hydraulic oil: ISO VG32  
 馬達轉速 Speed: 1800 rpm  
 油箱容積 Capacity of tank: 30L  
 室溫 Ambient Temperature: 30 °C

Continuous operated cylinder (Ø20xØ40x250mm)  
 W/cylinder working cycle: 12 strokes/min.  
 連續操作CYLINDER (Ø20xØ40x250mm)  
 作動頻率12次往返 / 每分鐘

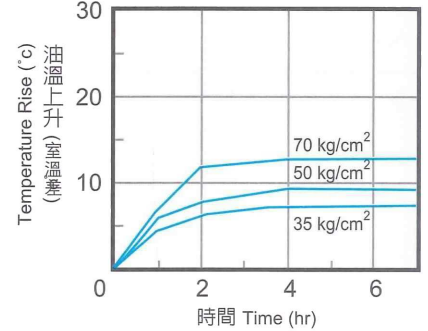
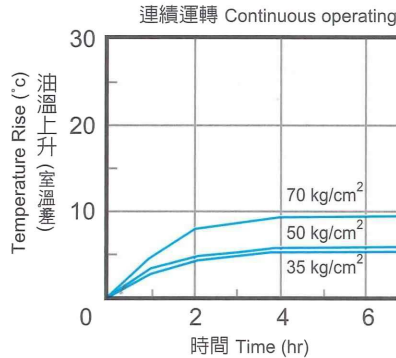

Continuous operated cylinder (Ø20xØ40x250mm)  
 W/cylinder working cycle: 12 strokes/min.  
 連續操作CYLINDER (Ø20xØ40x250mm)  
 作動頻率12次往返 / 每分鐘

### VCM - SF - SM - 30 ※ - 4CG - 30

測試條件 Testing condition  
 操作用油 Hydraulic oil: ISO VG32  
 馬達轉速 Speed: 1800 rpm  
 油箱容積 Capacity of tank: 40L  
 室溫 Ambient Temperature: 30 °C

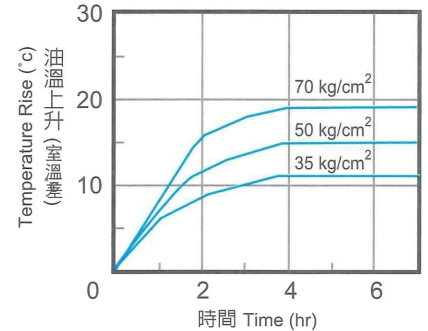
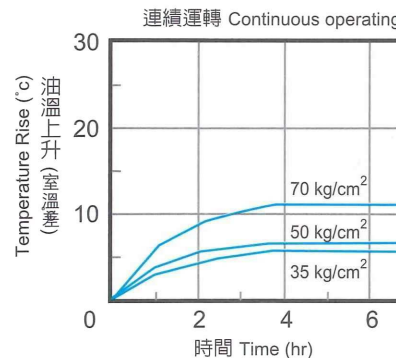

●規格修改，本公司不另行通知  
 ●Specification is subjected to change without notice.