

Dimensions

THF-06、10

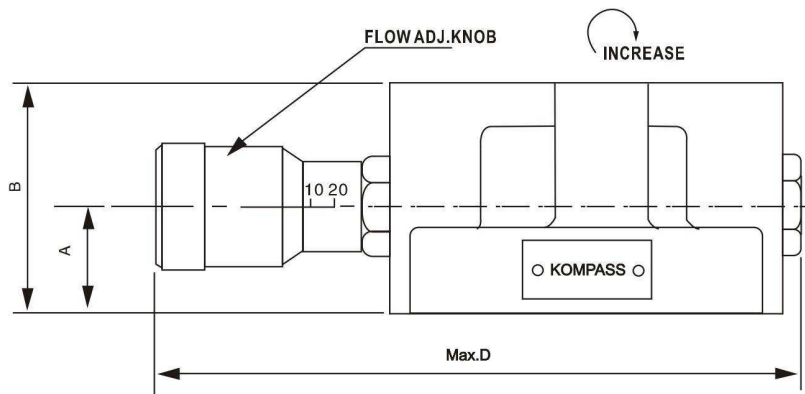
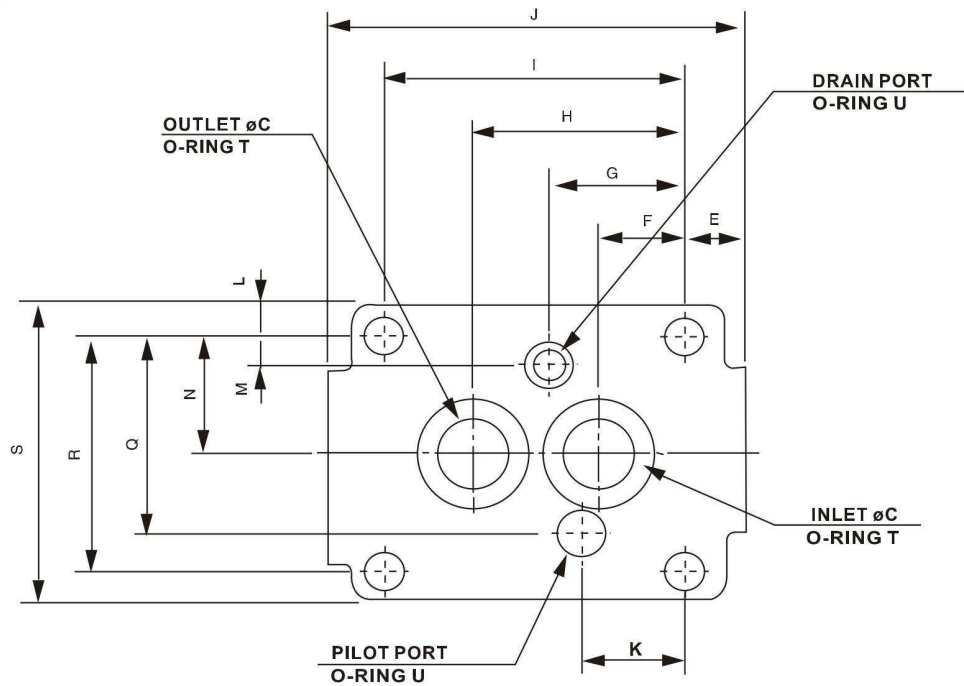

MODEL	A	B	C	D	E	F	G
THF-06	35	75	24	212	17.5	26	40.5
THF-10	45	86	29	250	19	34	47

MODEL	A	B	C	D	E	F	G
THF-06	64	90	125	31.7	10.5	9.5	37
THF-10	78	112	150	37.9	14.5	16	43

MODEL	A	B	C	D	E	MOUNTING SUBPLATE
THF-06	63	74	95	P28	P12	SFM-06 SEE PAGE P.60
THF-10	76	86	115	P34	P12	SFM-10 SEE PAGE P.60

Dimensions

SD-06、10

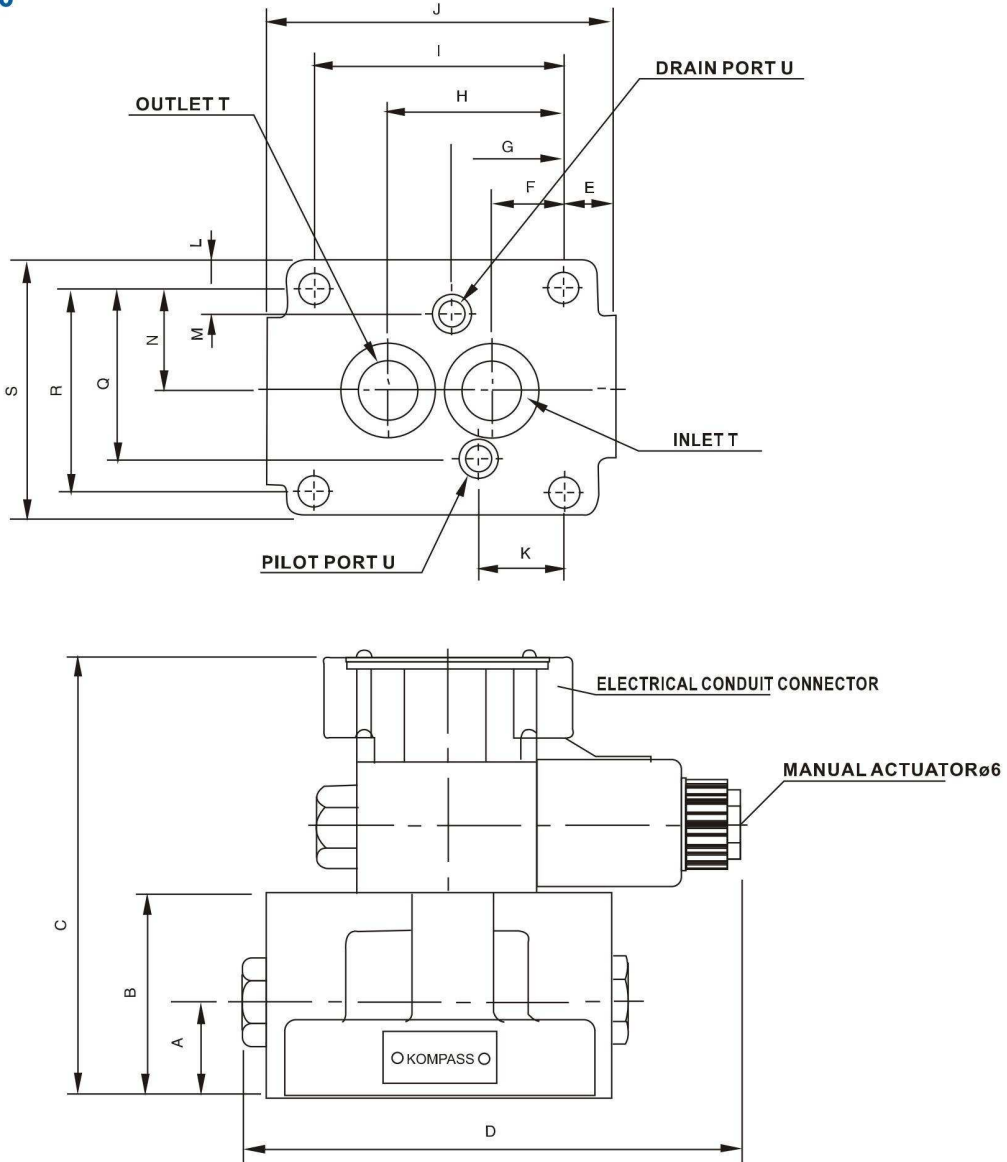

MODEL	A	B	C	D	E	F	G
SD-06	35	75	164	180	17.5	26	40.5
SD-10	45	86	173	197	19	34	47

MODEL	H	I	J	D	E	F	G
SD-06	64	90	125	31.7	10.5	9.5	37
SD-10	78	112	150	37.9	14.5	16	43

MODEL	Q	R	S	T	U	MOUNTING SUBPLATE
SD-06	63	74	95	$\phi 24$	$\phi 6$	SFM-06 SEE PAGE P.60
SD-10	76	86	115	$\phi 29$	$\phi 6$	SFM-10 SEE PAGE P.60

Dimensions

SF-06、10

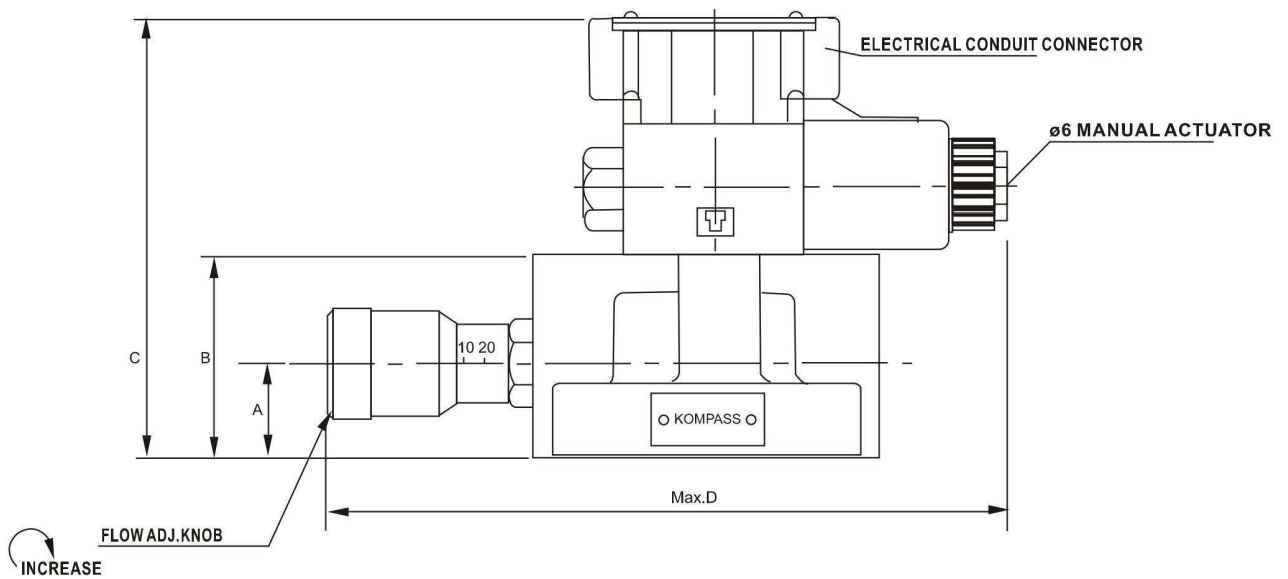
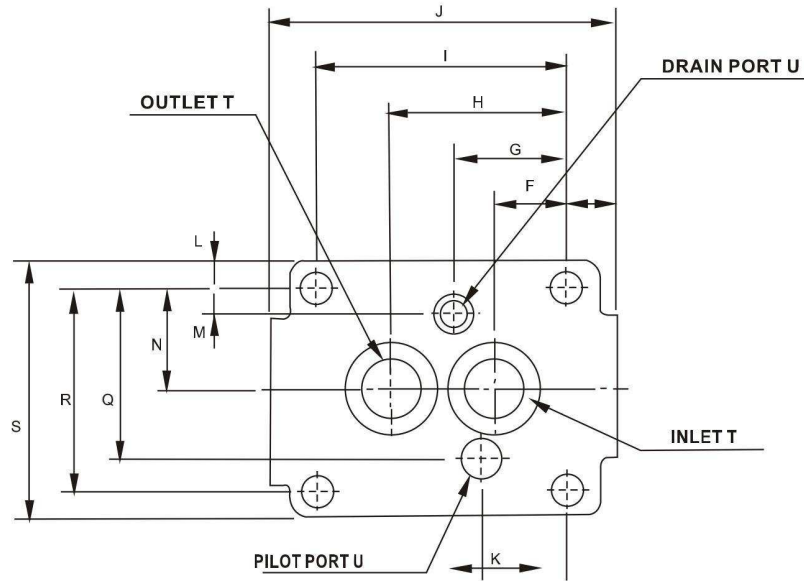

MODEL	A	B	C	D	E	F	G
SF-06	35	75	164	212	17.5	26	40.5
SF-10	40	86	173	250	19	34	47

MODEL	H	I	J	K	L	M	N
SF-06	64	90	125	31.7	10.5	9.5	37
SF-10	78	112 138	150	37.9	14.5	16	43

MODEL	Q	R	S	T	U	MOUNTING SUBPLATE
SF-06	63	74	95	φ24	φ6	SFM-06 SEE PAGE P.60
SF-10	76	86	115	φ29	φ6	SFM-10 SEE PAGE P.60

Dimensions

SDF-06、10

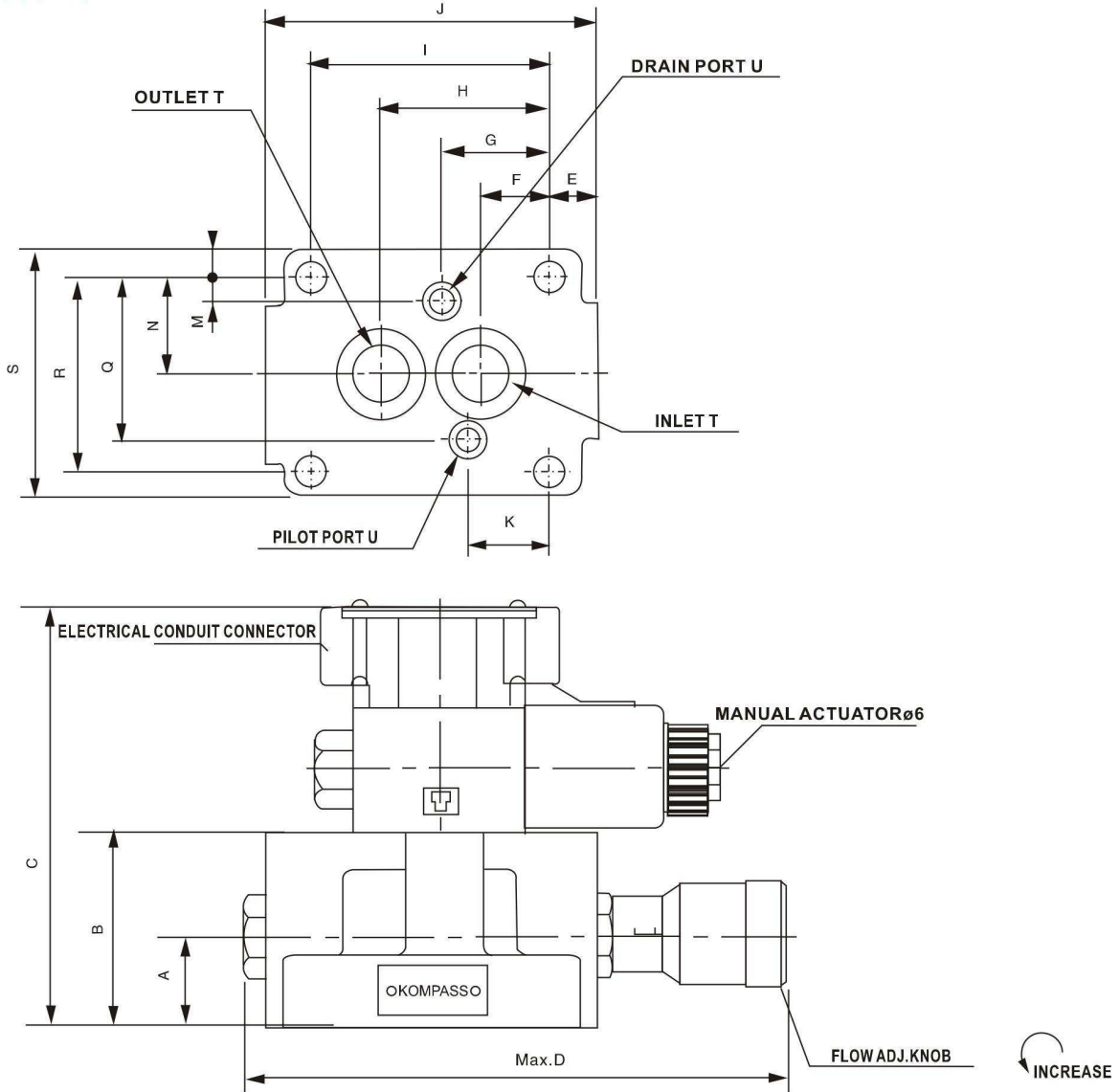

MODEL	A	B	C	D	E	F	G
SDF-06	35	75	164	212	17.5	26	40.5
SDF-10	45	86	173	250	19	34	47

MODEL	H	I	J	K	L	M	N
SDF-06	64	90	125	31.7	10.5	9.5	37
SDF-10	78	112	150	37.9	14.5	16	43

MODEL	Q	R	S	T	U	MOUNTING SUBPLATE
SDF-06	63	74	95	φ24	φ6	SFM-06 SEE PAGE P.60
SDF-10	76	86	115	φ29	φ6	SFM-10 SEE PAGE P.60

- 規格修改，本公司不另行通知
- Specification is subjected to change without notice.

Dimensions

SFD-06、10

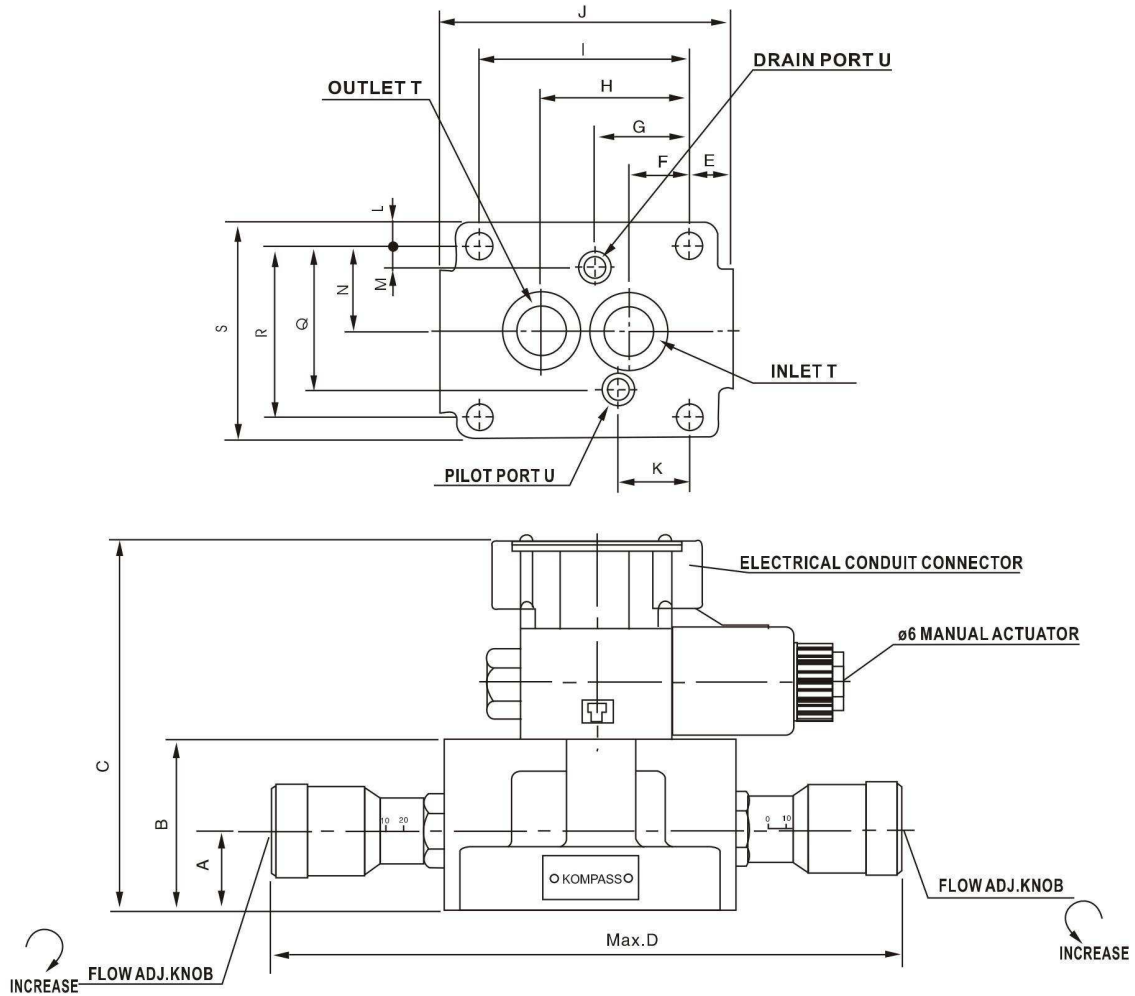

MODEL	A	B	C	D	E	F	G
SFD-06	35	75	24	212	17.5	26	40.5
SFD-10	45	86	29	250	19	34	47

MODEL	H	I	C	D	E	F	G
SFD-06	64	90	125	31.7	10.5	9.5	37
SFD-10	78	112	150	37.9	14.5	16	43

MODEL	Q	R	S	T	U	MOUNTING SUBPLATE
SF-06	63	74	95	φ24	φ6	SFM-06 SEE PAGE P.60
SF-10	76	86	115	φ29	φ6	SFM-10 SEE PAGE P.60

Dimensions

SKF-06

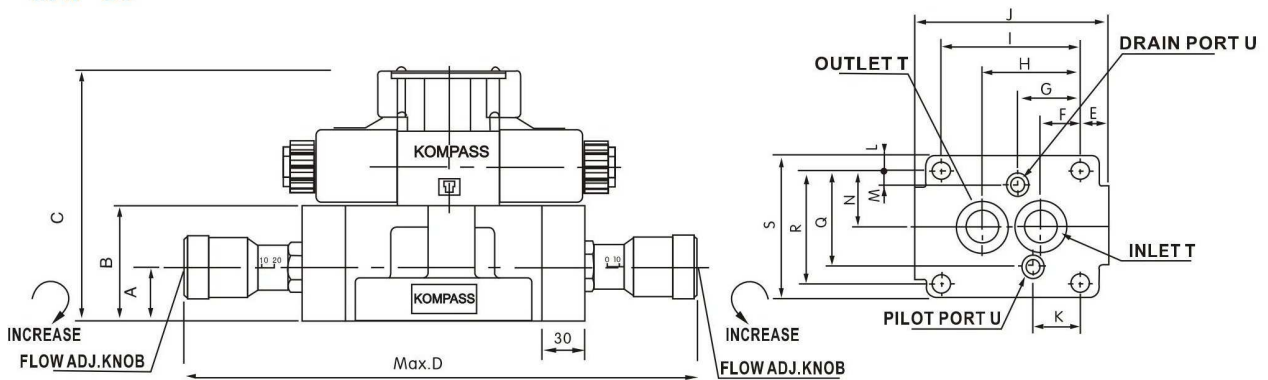

MODEL	A	B	C	D	E	F	G
SKF-06	35	77	164	335	17.5	26	40.5

MODEL	H	I	J	K	L	M	N
SKF-06	64	90	125	31.7	10.5	9.5	37

MODEL	Q	R	S	T	U	MOUNTING SUBPLATE
SF-06	63	74	95	φ24	φ6	SFM-06 SEE PAGE P.60

- 規格修改，本公司不另行通知
- Specification is subjected to change without notice.